

Technical Challenges in Enterprise Imaging

David A. Clunie

PixelMed Publishing, LLC

Financial Disclosures

- Grants/Research Support: NCI (Essex, BWH)
- Consulting Fees: MDDX, Carestream, GE, Curemetrix, NEMA
- Editor of DICOM Standard (NEMA/MITA Contractor)
- Other: Owner of PixelMed Publishing

Technical Challenges

- Interoperability
- Metadata
- Workflow
- Simpler DICOM services (DICOMweb)
- Color Consistency
- Privacy and Security

Interoperability

“the ability of two or more systems or components to exchange information and to use the information that has been exchanged”

IEEE Standard Computer Dictionary: A Compilation of IEEE Standard Computer Glossaries. 1990

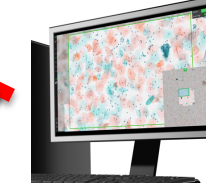
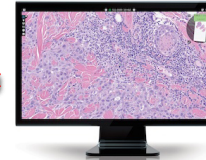
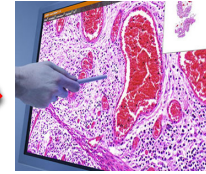
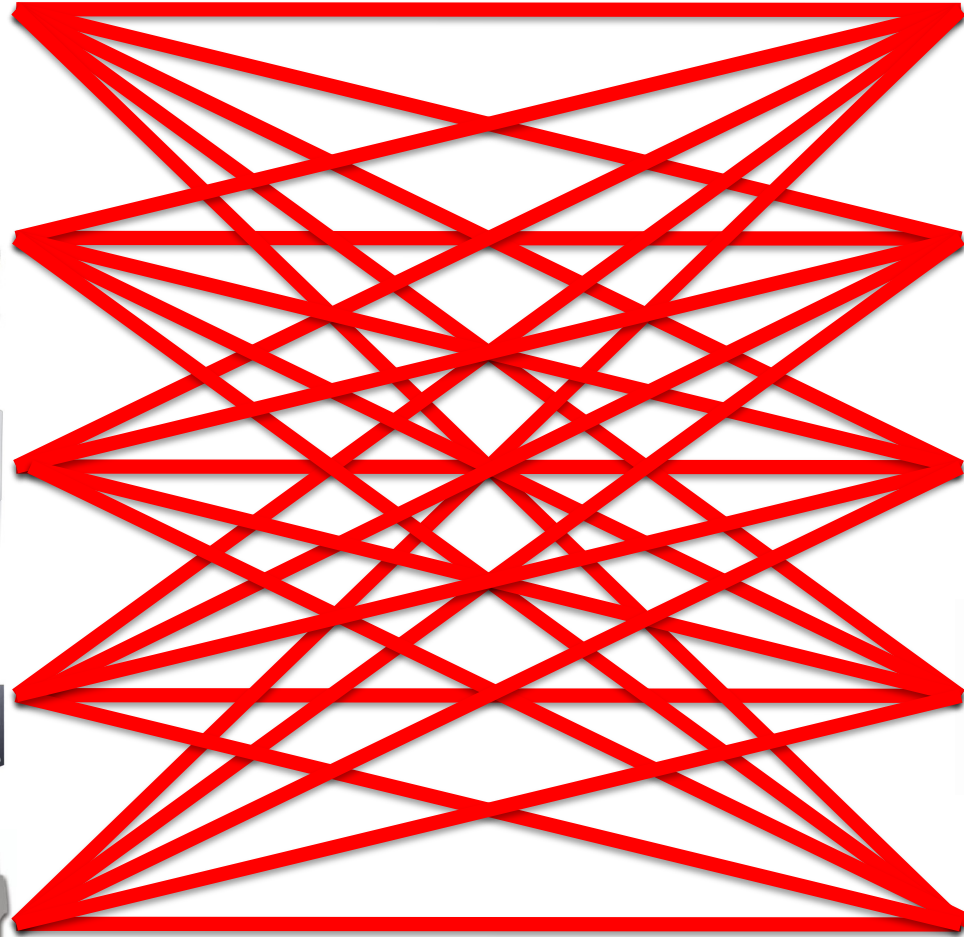
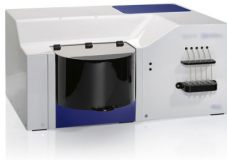

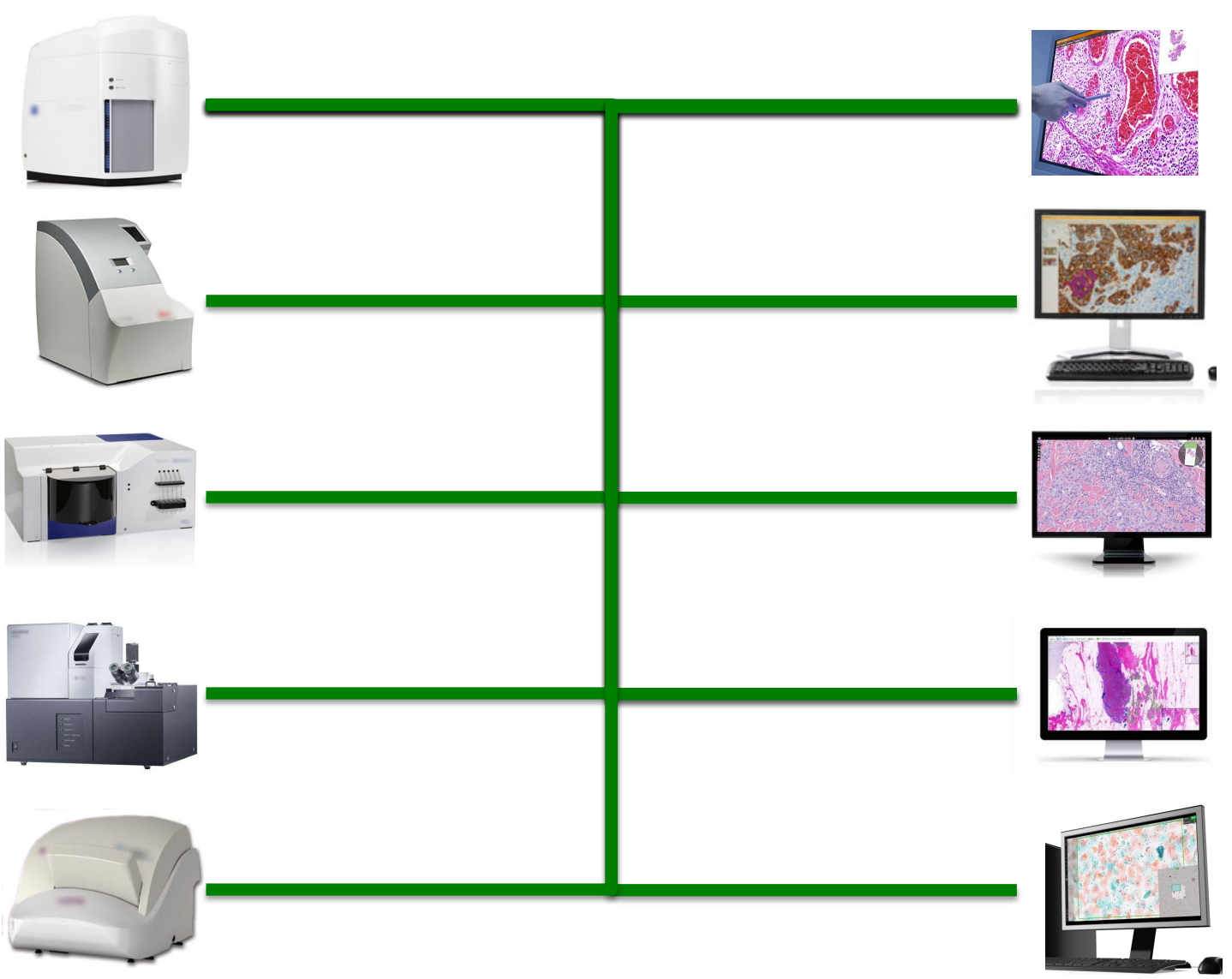

Photoelectronic radiology department

M. Paul Capp, Sol Nudelman, Donald Fisher, Theron W. Ovitt, Gerald D. Pond,
Meryl M. Frost, Hans Roehrig, Joachim Seeger, Donald Oimette
Department of Radiology, University of Arizona Health Sciences Center, Tucson, Arizona 85724

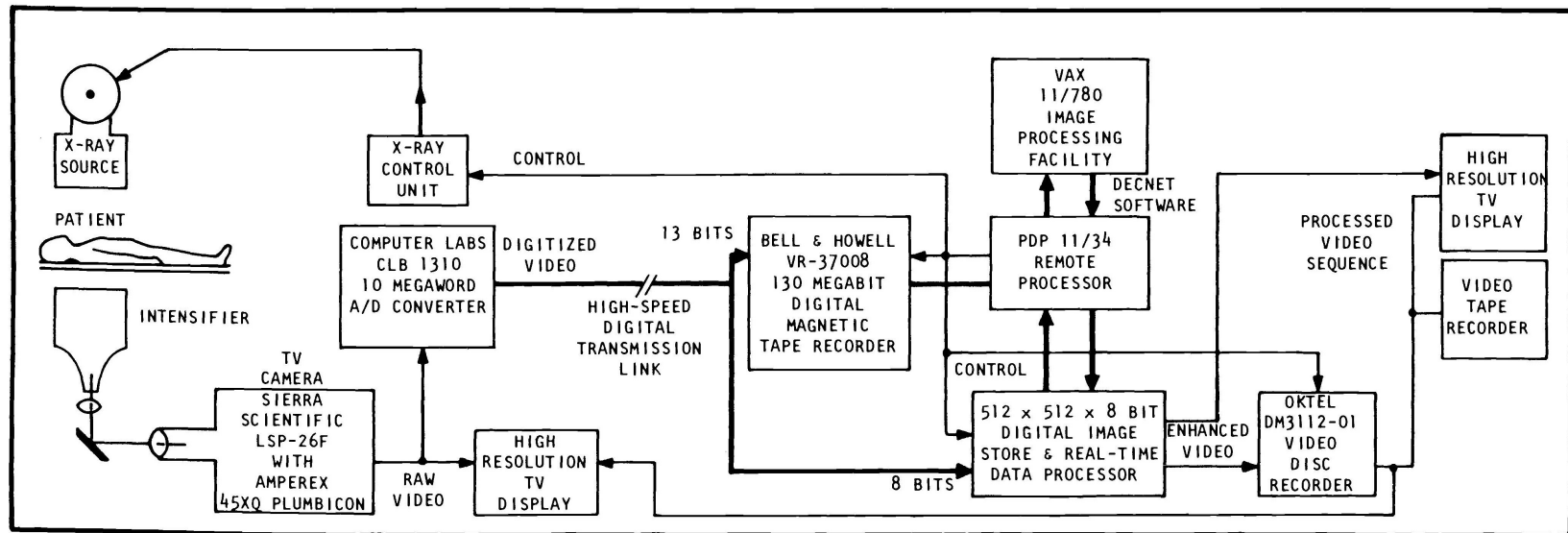

Figure 1. System block diagram of demonstration facility.

PROCEEDINGS

Of SPIE-The International Society for Optical Engineering



Volume 318

1st International Conference and Workshop on

PICTURE ARCHIVING AND COMMUNICATION SYSTEMS (PACS)

FOR MEDICAL APPLICATIONS

Part I

André J. Duerinckx
Chairman/Editor

 IEEE COMPUTER SOCIETY



 THE INSTITUTE OF ELECTRICAL AND ELECTRONICS ENGINEERS

IEEE Catalog No. TH000...
IEEE Computer Society Catalog No. 388

January 18-21, 1982
Newport Beach, California

1982

SESSION 9. STANDARDIZATION OF PACS	269
318-48 The role of standards in the development of systems for communicating and archiving medical images	270
Roger H. Schneider, FDA, Bureau of Radiological Health	
318-49 IEEE logical format for external exchange of image data bases	272
Judith M. S. Prewitt, National Institutes of Health	
318-50 Characteristics of a protocol for exchanging digital image information	273
Brent Baxter, Lewis Hitchner, Gerald Maguire, Jr., University of Utah Medical Center	
318-51 Landsat computer-compatible tape family	278
Fred C. Billingsley, Jet Propulsion Laboratory	
318-52 An American Association of Physicists in Medicine (AAPM) standard magnetic tape format for digital image exchange	284
G. Q. Maguire, Jr., Brent S. Baxter, Lewis E. Hitchner, University of Utah	
318-53 On standards for the storage of images and data	294
M. J. Haney, R. L. Johnston, W. D. O'Brien, Jr., University of Illinois	
318-54 Proposed standard for variable format picture processing and a codec approach to match diverse imaging devices	298
Th. Wendler, D. Meyer-Ebrecht, James M. Jemiola, Philips Research Center, Hamburg, FRG	

32 years ago – radiology PACS and DICOM ubiquitous 15-20 years later!

DICOM – Diversity from early on ...

- DICOM has been around a very long time (1985 ACR-NEMA)
- DICOM has been doing more than radiology for a long time too
- Cardiology – 1995
- Radiotherapy – 1996
- Visible Light – 1998 – including Slide Microscopy
- Even before that – Secondary Capture RGB – 1993
- Increasingly specialty specific image types and metadata
- Whole Slide Imaging – 2010
- Ophthalmic Tomography Angiography – 2017

Store, Find & Regurgitate +/- View



Storing anything and everything

- ... with DICOM ...
- Specific SOP Class and IOD – e.g., Ophthalmic Photography
- Generic SOP Class and IOD – e.g., VL Photographic
- Anything at all SOP Class & IOD – e.g., Secondary Capture
- Distinguished by Pixel Data restrictions & metadata
- Pixel Data “payload” – uncompressed or compressed (e.g., JPEG-*, MPEG-*)
- Metadata (“header”) – composite (shared) and modality (clinical application) specific

Visible Light IODs and SOP Classes

- VL Endoscopic Image (IOD and Storage SOP Class)
- VL Microscopic Image
- VL Slide-Coordinates Microscopic Image
- VL Photographic Image

- Video Endoscopic Image
- Video Microscopic Image
- Video Photographic Image

- VL Whole Slide Microscopy Image

Ophthalmic IODs and SOP Classes

- Ophthalmic Photography 8 bit Image
- Ophthalmic Photography 16 bit Image
- Ophthalmic Tomography Image
- Ophthalmic Refractive Measurements (Lensometry, Visual Acuity, ...)
- Ophthalmic Visual Field Static Perimetry Measurements
- Ophthalmic Thickness Map
- Wide Field Ophthalmic Photography Stereographic Projection Image
- Wide Field Ophthalmic Photography 3D Coordinates Image
- Ophthalmic Optical Coherence Tomography En Face Image
- Ophthalmic Optical Coherence Tomography B-scan Volume Analysis



It's the metadata, stupid

<http://medium.com/digital-trends-index/its-the-metadata-stupid-12a4fc121e45#.4zhwdz5y0>

Composite Context

- All of the stuff that is the same across multiple images (files, instances) ... i.e., of the DICOM Composite Information Model:
 - Patient ... same for all instances for patient
 - Study ... same for all instances for procedure
 - Series ... new for each related acquisition or derivation
 - Equipment
 - Multi-Frame Dimensions
 - Frame of Reference ... e.g., if same slide coordinates
- Provides the basis for database/browser structure

Composite Information Model

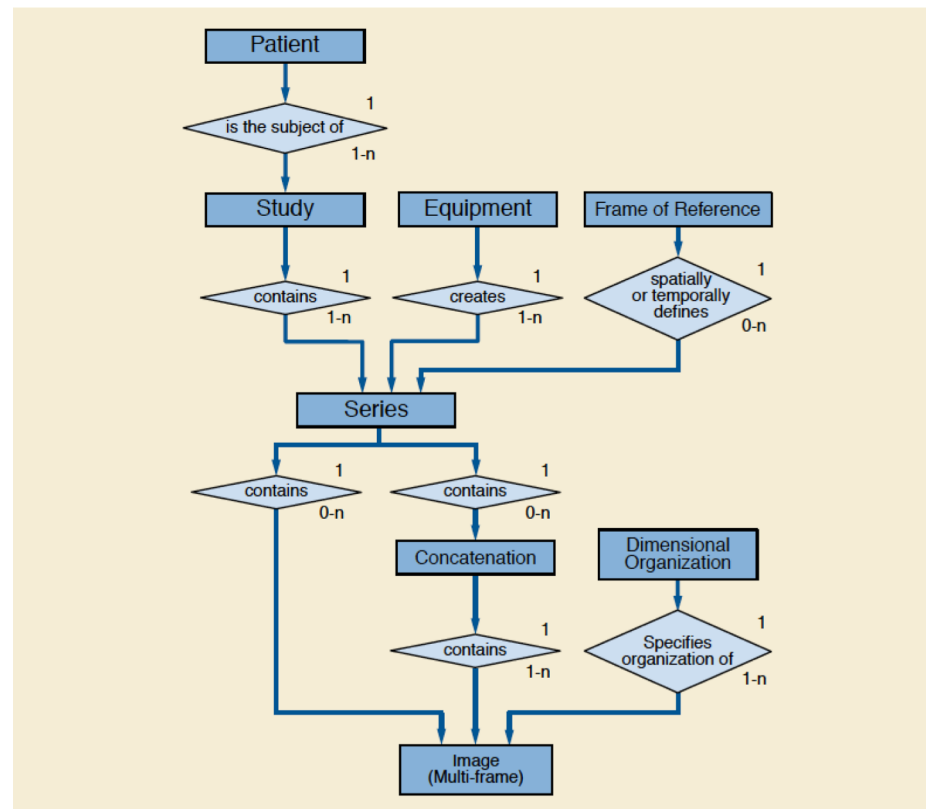

Extreme Metadata – or not

- Every image needs the Pixel Data described (rows, columns, bit depth, etc.), and unique identifiers
- Beyond that lot or a little, whatever is needed
- Bare minimum – some identifier to match some other system – recipient does the matching work
- Everything and the kitchen sink – detailed description of the patient's state, acquisition process, etc., using standard string values or codes – recipient is passive
- The latter is the norm in radiology

Minimum Chips

- As little as possible in one of the generic SOP Classes
- Very few required Type 1 elements
- Type 2 required elements may be “empty” if unknown
- Only Patient ID (empty name, DOB, age, sex – server will lookup, coerce)
- Send Content (or Acquisition) Date and Time only – server (or user) can match to other records captured contemporaneously
- Absent/empty Accession Number, Admission ID, Service Episode ID
- Make up some (Study, Series, Instance) UIDs
- With STOW-RS, can even omit the Pixel Data description, and let the server figure it out from the JPEG payload

More than is strictly necessary

- Can do better by adding what is relevant to the recipient
- Textual descriptions (e.g., in Study/Series Description, Image Comments)
- Modality – more specific than “other”
- A little anatomy – may be hardwired (e.g., knee arthroscopy, colonoscopy, retinal fundoscopy) or user controlled (e.g., handheld skin lesion photos) – is best coded (e.g., SNOMED, FMA, clinical specialty codes such as NYU Melanoma CCG) rather than just text string
- Guiding principle – what can the recipient benefit from that is not too burdensome to capture?
- Radiology experience – rich metadata drives hanging protocols, prior pre-fetching, finding the right stuff in the study/series browser

Surface Anatomy – NYU, Mayo

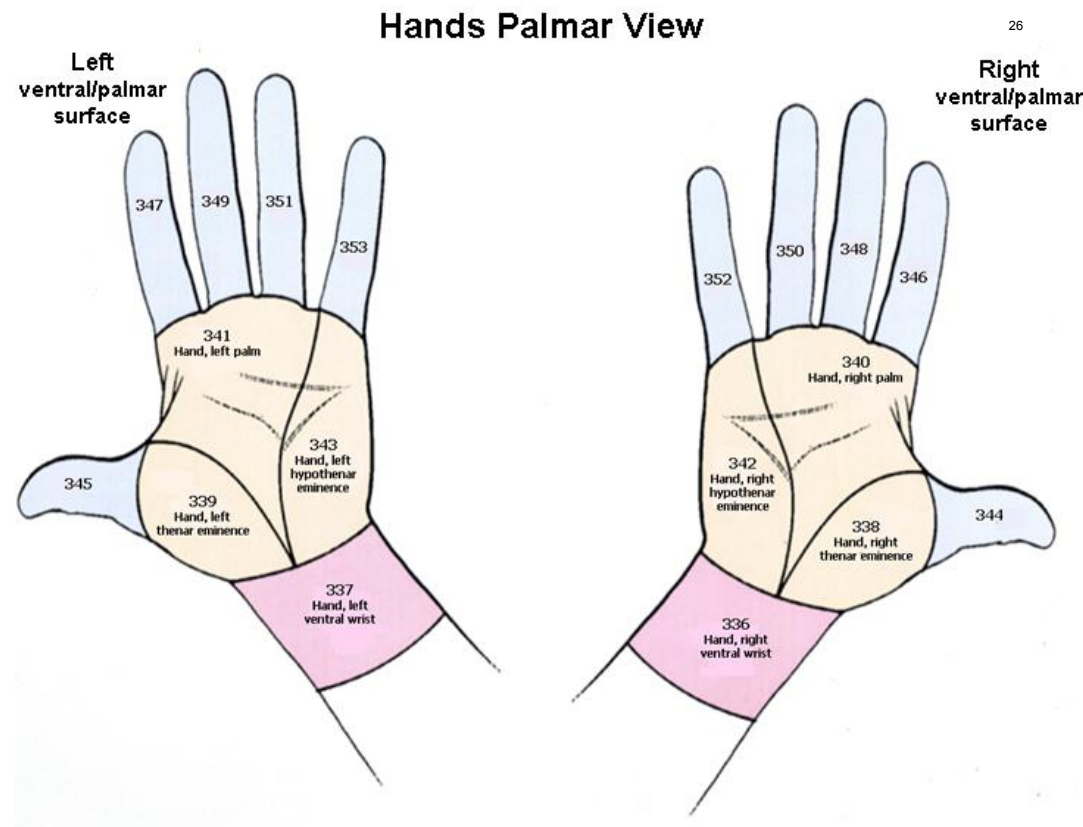

Surface Anatomy – NYU, Mayo

Coding Scheme Designator	Code Value	Code Meaning	SNOMED-CT Concept ID	UMLS Concept Unique ID	FMA ID	NYUMCCG Numeric Code	NYUMCCG Description	Mayo Numeric Code	Mayo Description
FMA	54343	Nail of left little Finger		C0926382	54343	335	Nail of the Little Finger of the Left Hand	335	Hand, left fifth fingernail
FMA	38284	Skin of anterior part of right wrist		C0829680	38284	336	Volar Right Wrist	336	Hand, right ventral wrist
FMA	38285	Skin of anterior part of left wrist		C0829681	38285	337	Volar Left Wrist	337	Hand, left ventral wrist
FMA	79168	Skin of right thenar eminence		C2338531	79168	338	Thenar Eminence of the Right Hand	338	Hand, right thenar eminence
FMA	79169	Skin of left thenar eminence		C2329983	79169	339	Thenar Eminence of the Left Hand	339	Hand, left thenar eminence
FMA	38302	Skin of palm of right hand		C0829695	38302	340	Palmar Surface of the Right Hand	340	Hand, right palm
FMA	38303	Skin of palm of left hand		C0829696	38303	341	Palmar Surface of the Left Hand	341	Hand, left palm
FMA	79165	Skin of right hypothenar eminence		C2328058	79165	342	Hypothenar Eminence of the Right Hand	342	Hand, right hypothenar eminence
FMA	79166	Skin of left hypothenar eminence		C2334824	79166	343	Hypothenar Eminence of the Left Hand	343	Hand, left hypothenar eminence

Extremely rich metadata

- All sorts of stuff relevant to the interpretation
- Even if another local source, needed when image is exported
- Identification and description of the patient
- Other Patient IDs, age, height, weight
- Patient (or specimen) preparation, positioning
- Acquisition process (e.g., illumination, filtration)
- Special aspects of the technique (e.g., fluorescence)

Why this matters

- Why not just save “consumer format” data in a content management system, and let it worry about the metadata?
- Export beyond the system (enterprise) – transfer, referrals
- Import from elsewhere – where does the metadata come from?
- Migrations – VNAs, CMS, EMRs go end-of-life just like PACS do – do you really want to repeat the pain of your last legacy PACS migration with its proprietary database and non-standard internal file format and proprietary compression?
- Mergers and acquisitions – when you get swallowed, your new owner will want to assimilate you, and standards (DICOM) help



Camera





Camera

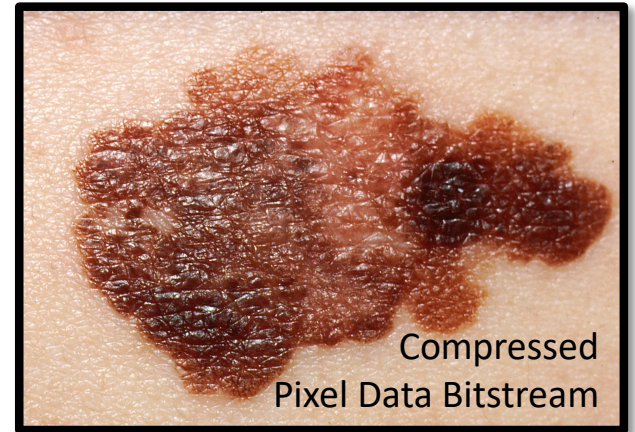

Compressed
Pixel Data Bitstream



Camera

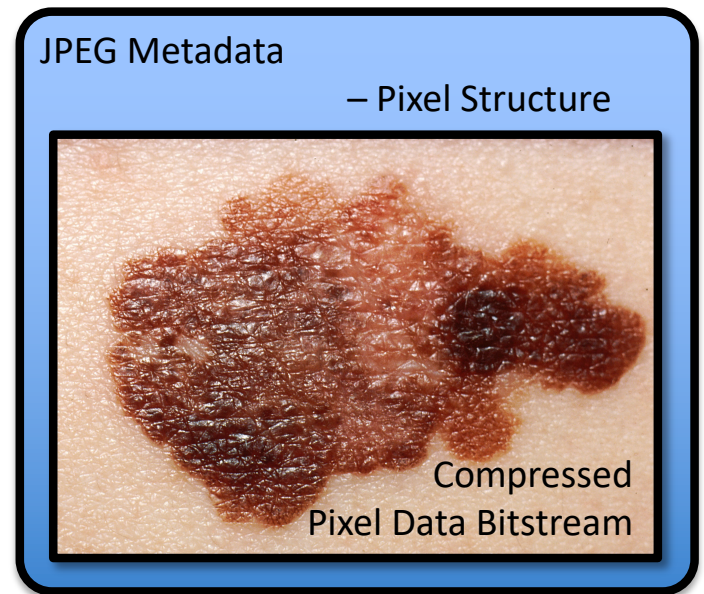



Camera

JPEG Metadata – EXIF, ICC Profile
– Pixel Structure

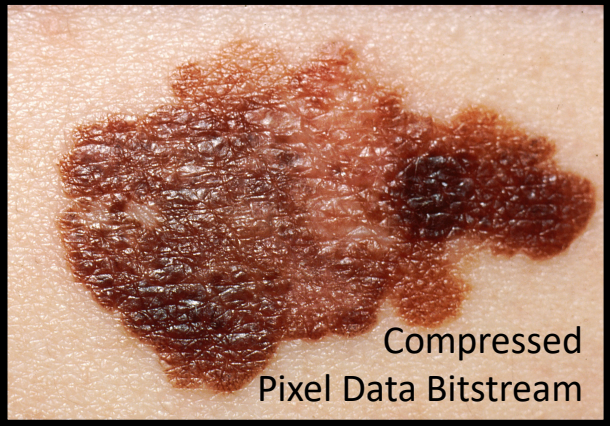

Compressed
Pixel Data Bitstream

The complex block is a light blue rounded rectangle with a black border. It contains text at the top and an image in the center. The text at the top is split into two lines: 'JPEG Metadata' followed by a list of items: '– EXIF, ICC Profile' and '– Pixel Structure'. The image in the center is a close-up photograph of a dark brown mole on a person's skin. Below the image, the text 'Compressed Pixel Data Bitstream' is written in two lines.



Camera

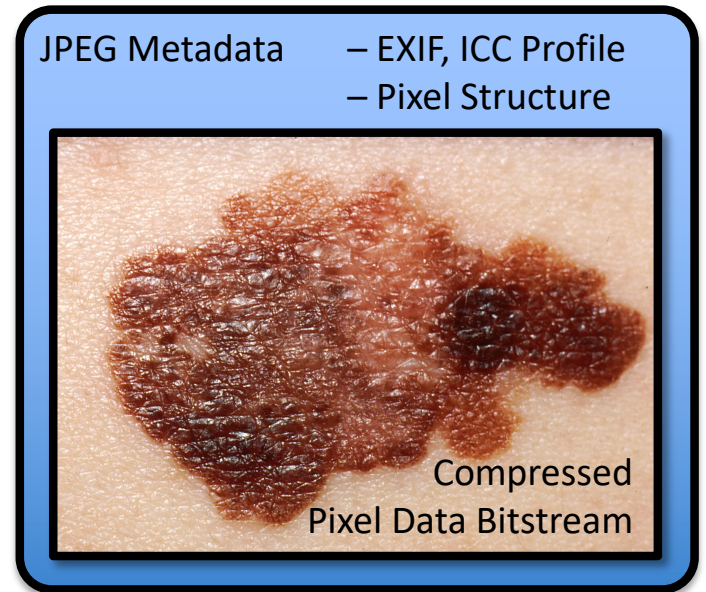
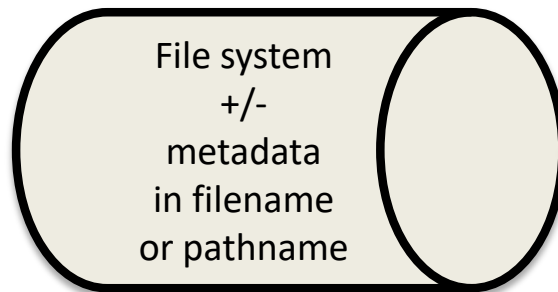

Metadata – Solution 1

Do it with DICOM

DICOM File



Camera

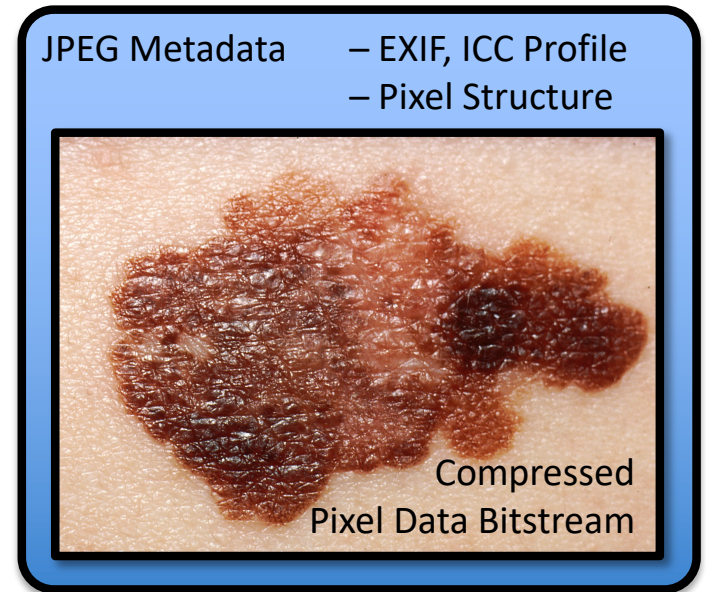
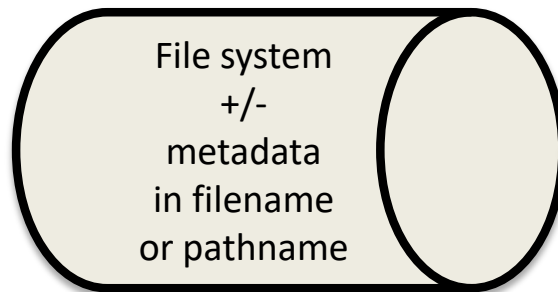

DICOM File



Camera

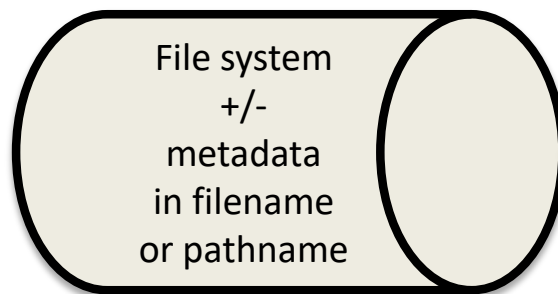

File system
+/-
metadata
in filename
or pathname

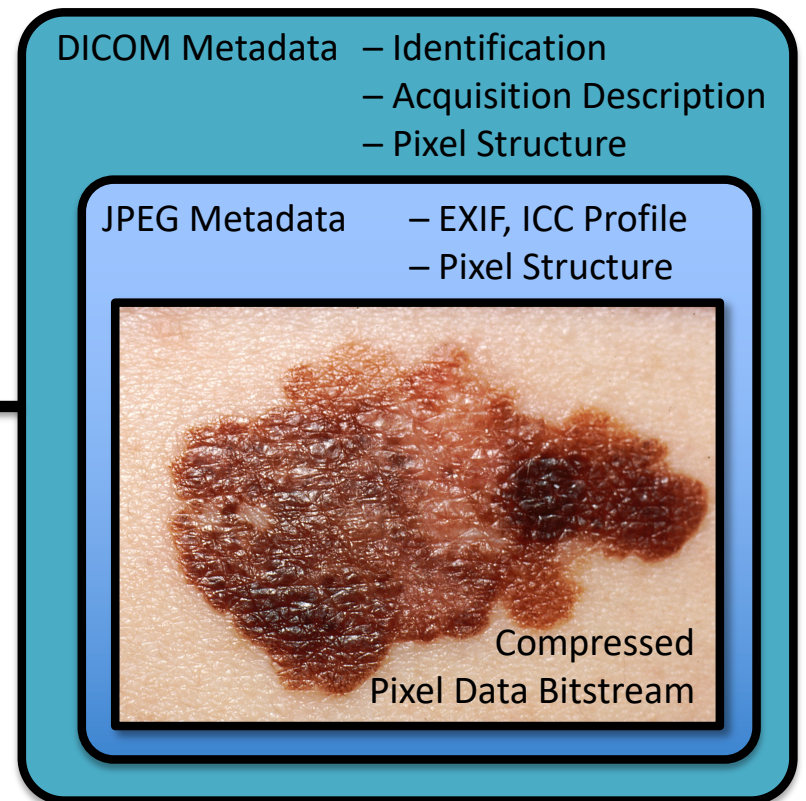

DICOM Metadata – Identification
– Acquisition Description
– Pixel Structure

JPEG Metadata – EXIF, ICC Profile
– Pixel Structure

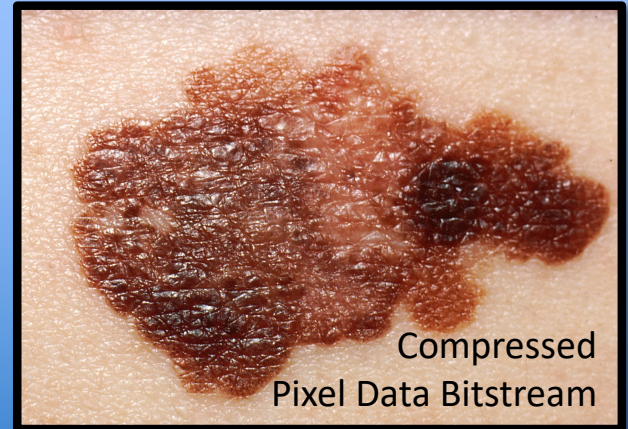

Compressed
Pixel Data Bitstream

DICOM Fileset



Camera

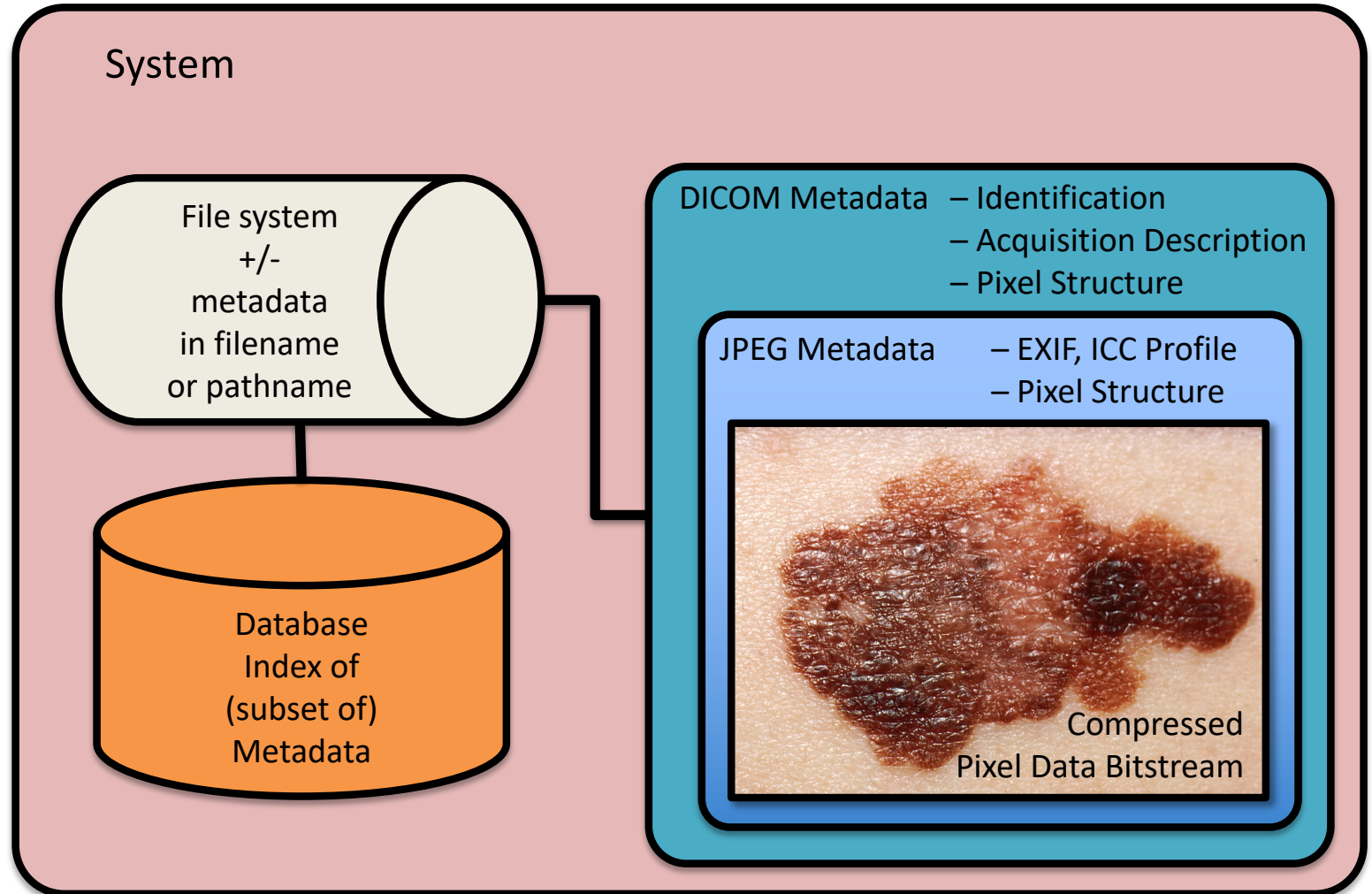

DICOM PACS



Camera

System

File system
+/-
metadata
in filename
or pathname

Database
Index of
(subset of)
Metadata

DICOM Metadata – Identification
– Acquisition Description
– Pixel Structure

JPEG Metadata – EXIF, ICC Profile
– Pixel Structure

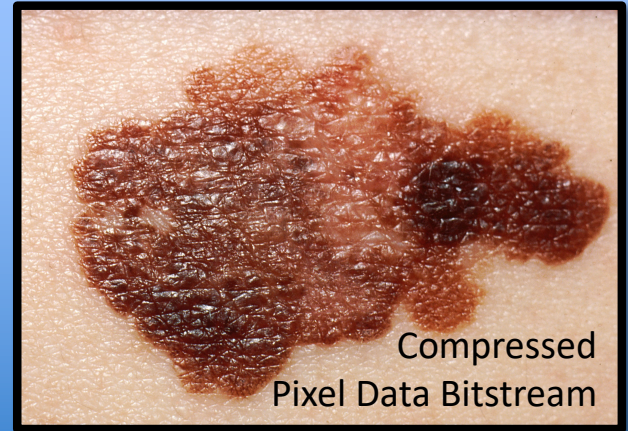

Compressed
Pixel Data Bitstream

DICOM Protocol

DICOM PACS

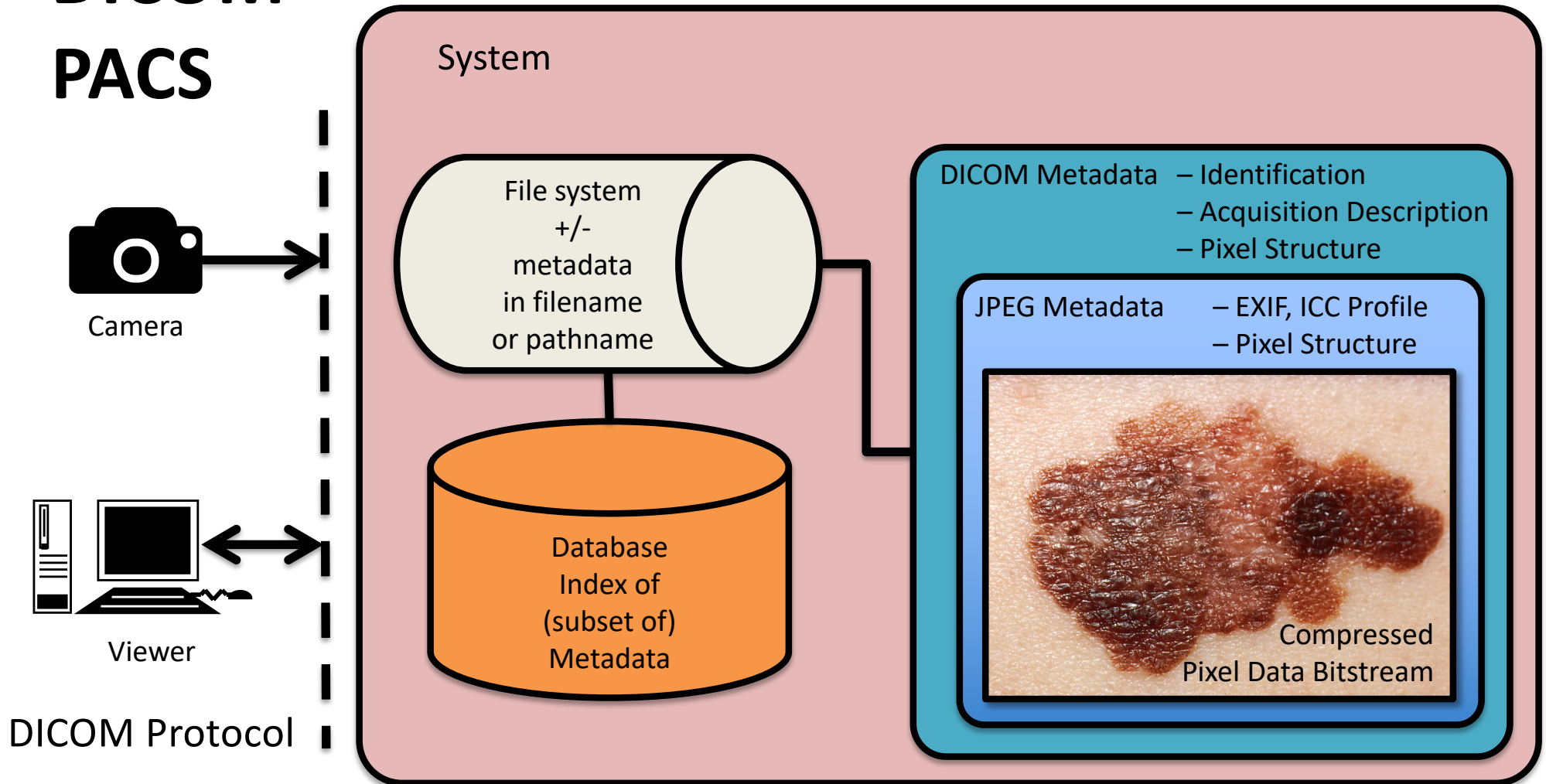

Metadata – Solution 2

Do it with EMR

“non-DICOM images”

EMR

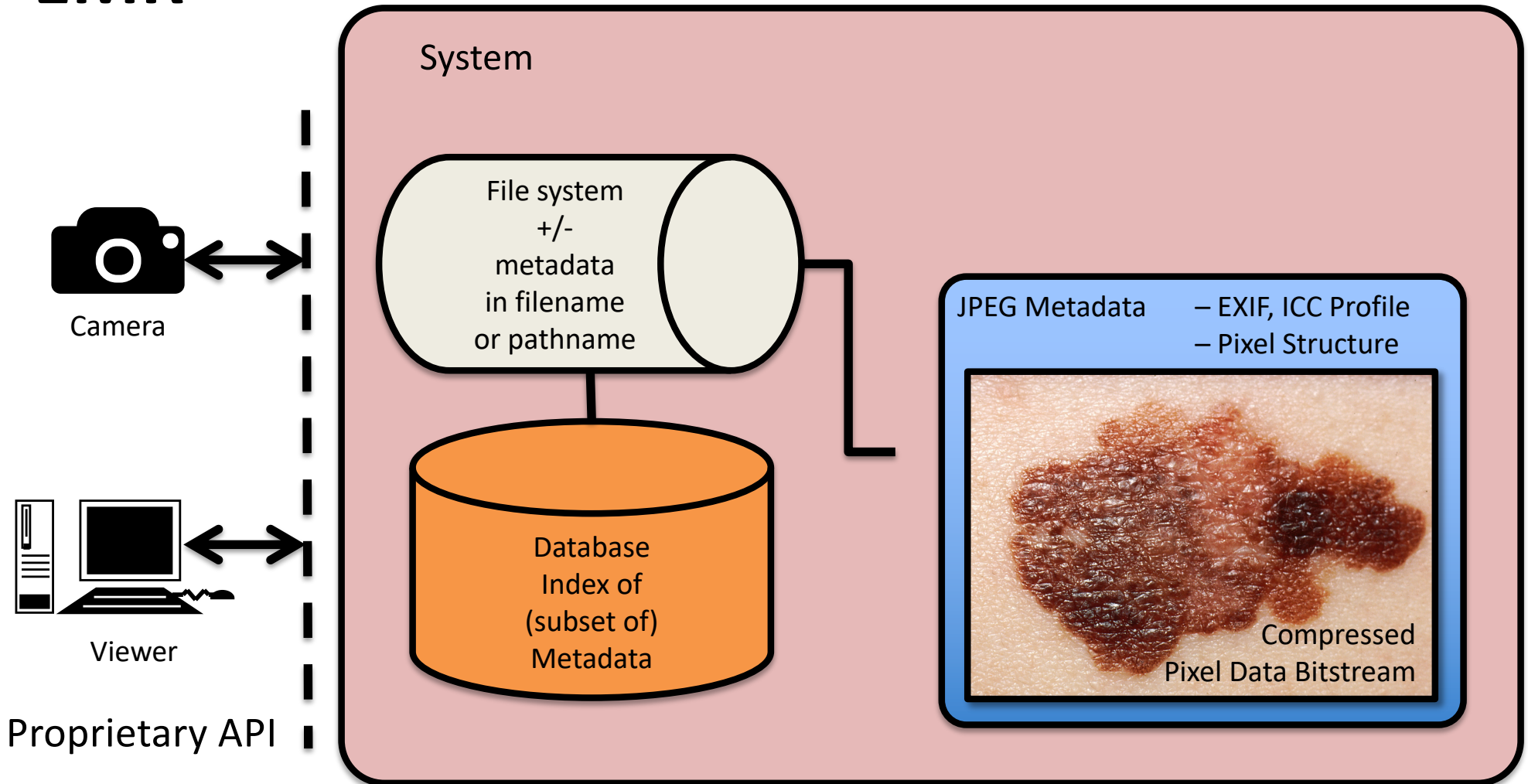

EMR

Export, Migration, Analysis, ...

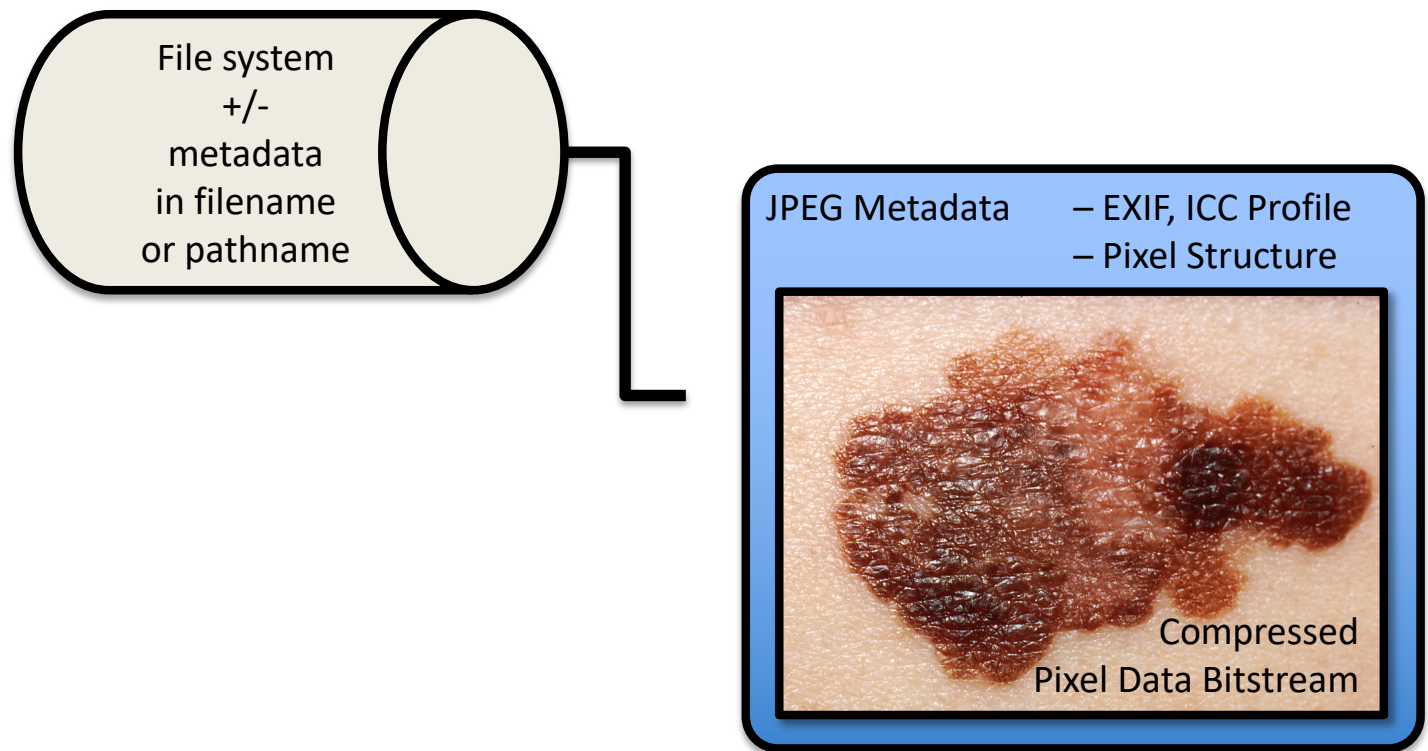

EMR

Export, Migration, Analysis, ...

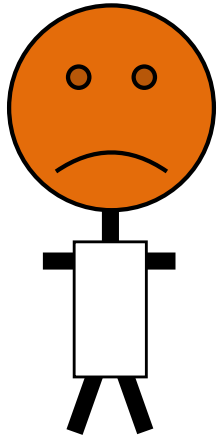
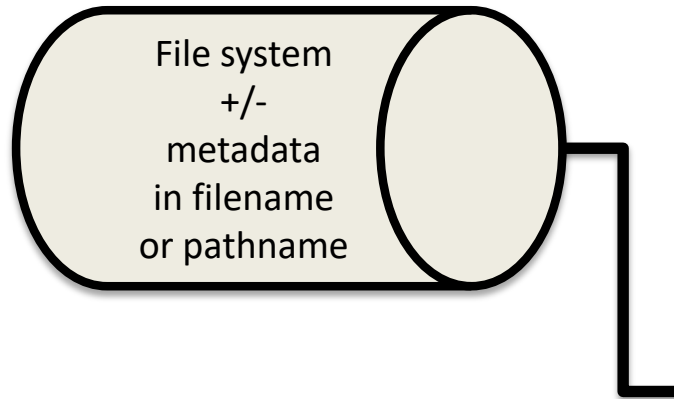

- What patient?
- What body part?
- What encounter?
- What date?
- ...

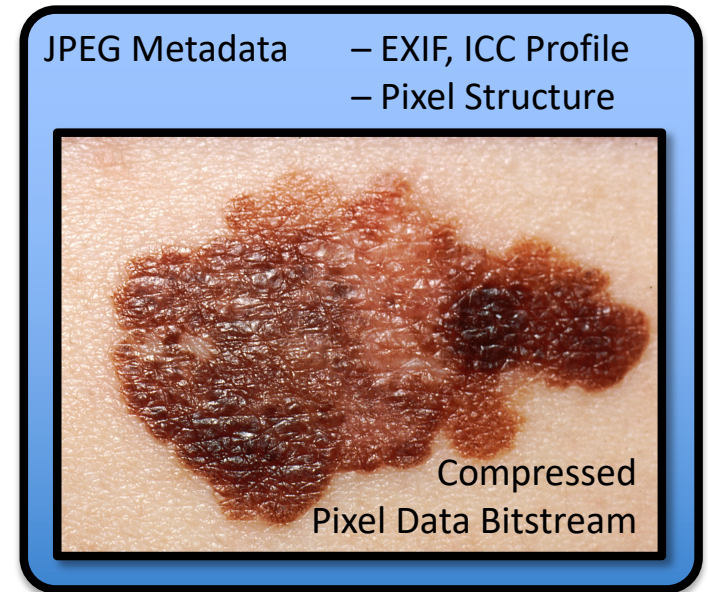

Metadata – Section 2

Do it with EMR

“non-DICOM images”

Metadata – Solution 3

Do it with XDS

“non-DICOM images”

XDS

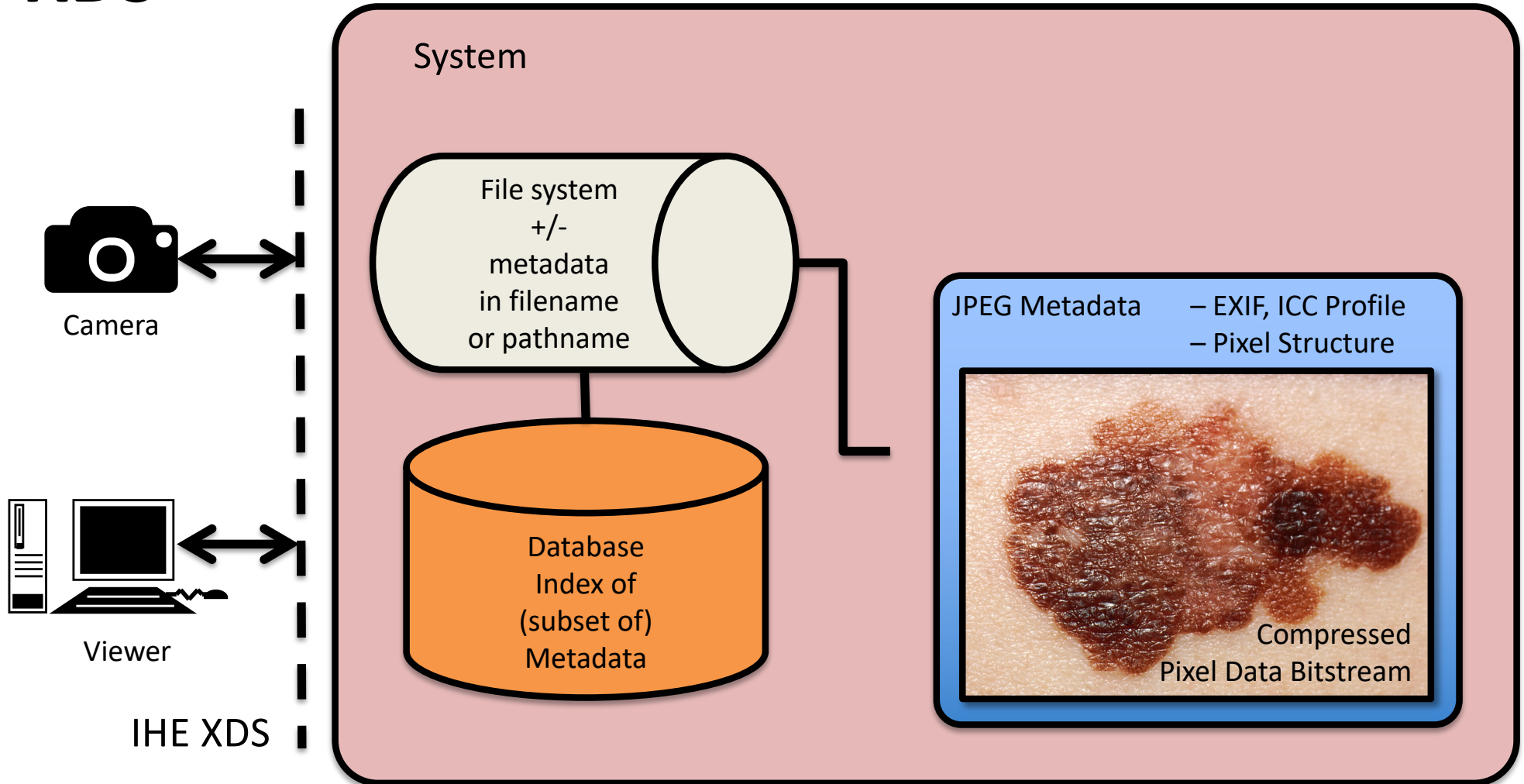

XDS

Export, Migration, Analysis, ...

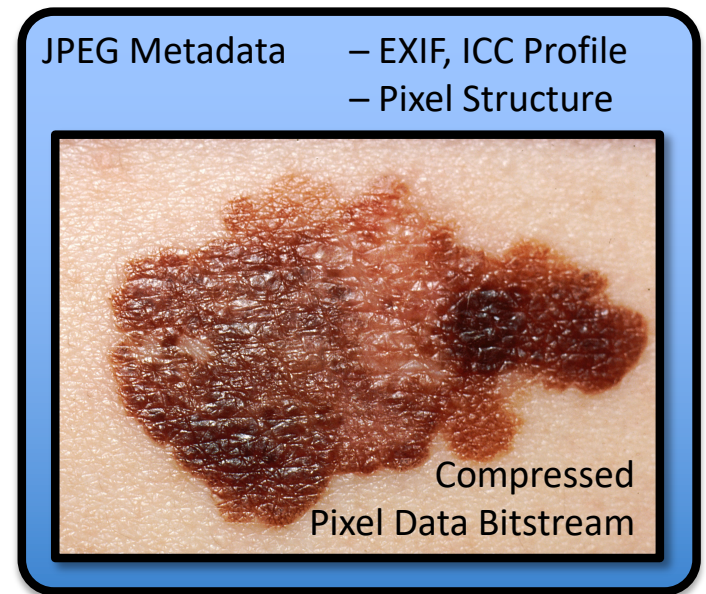

XDS

Export, Migration, Analysis, ...

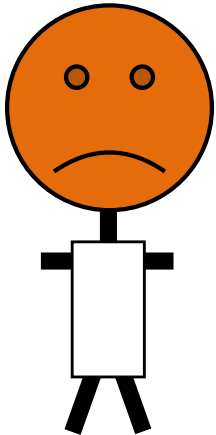

- What patient?
- What body part?
- What encounter?
- What date?
- ...

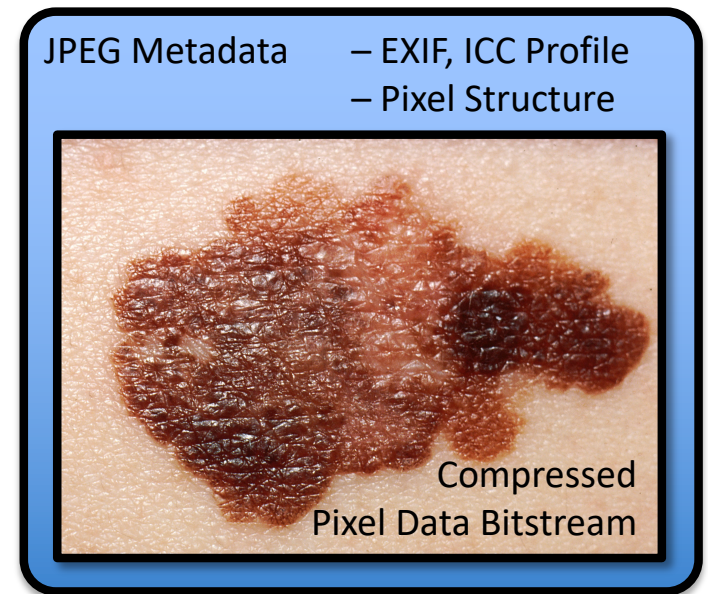

Metadata – Section 3

Do it with XDS

“non-DICOM images”



*Detachment
Sucks!*

*without embedded
metadata, that is*

From whence cometh metadata

- Manual data entry sucks (and is error prone)
- It lives naturally in HIS, departmental IS, EMR
- Which broadcast (or can be configured to send) HL7 V2 on various “trigger events”
- Asynchronous stuff sucks (since it may come when the acquisition device is least expecting it) – devices may be “intermittently connected”
- A 3rd party can cache it and responds to queries for it – hence DICOM Modality Worklist was born
- Today one might reinvent it with queries on FHIR resources

MWL beyond Radiology

- DICOM MWL does NOT depend on their being an order
- A clinic visit can trigger a worklist entry
- Admission, Service Episode IDs in work lists to provide matching to “encounters”
- Cardiology – typically not “ordered” and even if ordered, morph during the procedure (e.g., from diagnostic cath to interventional)
- Extensive VA use for ophthalmology, endoscopy, dentistry
- Joint VA/DoD DICOM Modality Conformance Requirements –
http://www.va.gov/health/IMAGING/docs/Joint_DICOM_Req_Doc_V_3_0_upd.pdf

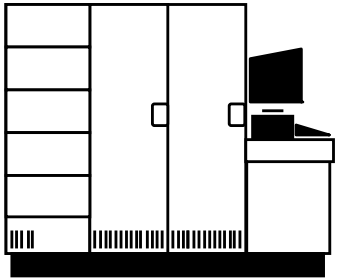

MWL Provider

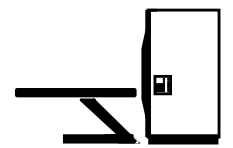

Modality

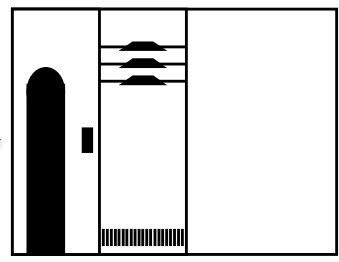

Archive

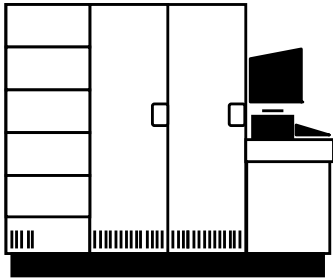

MWL Provider



Camera

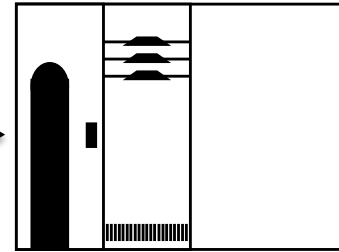

Archive

Order-Based

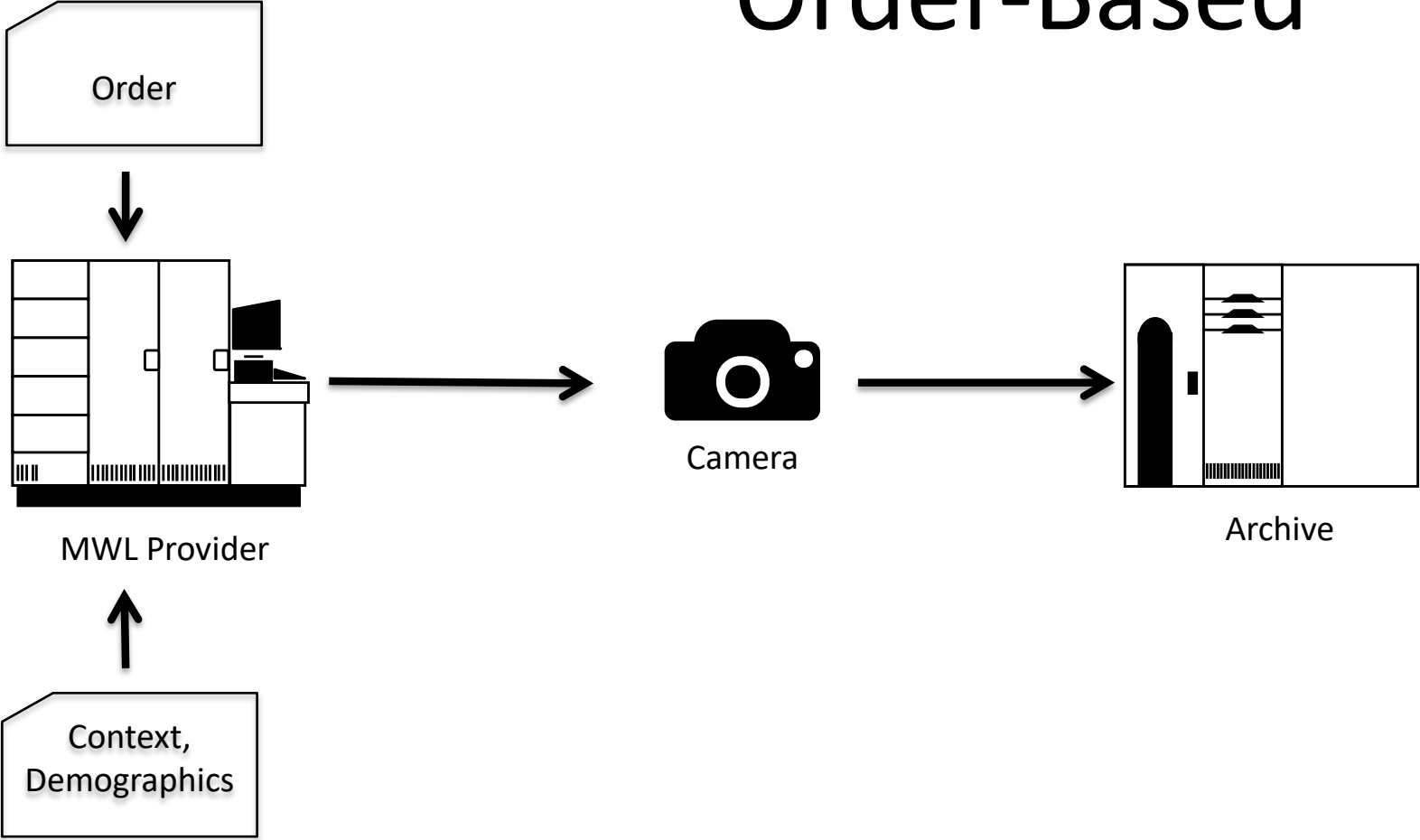

Encounter-Based

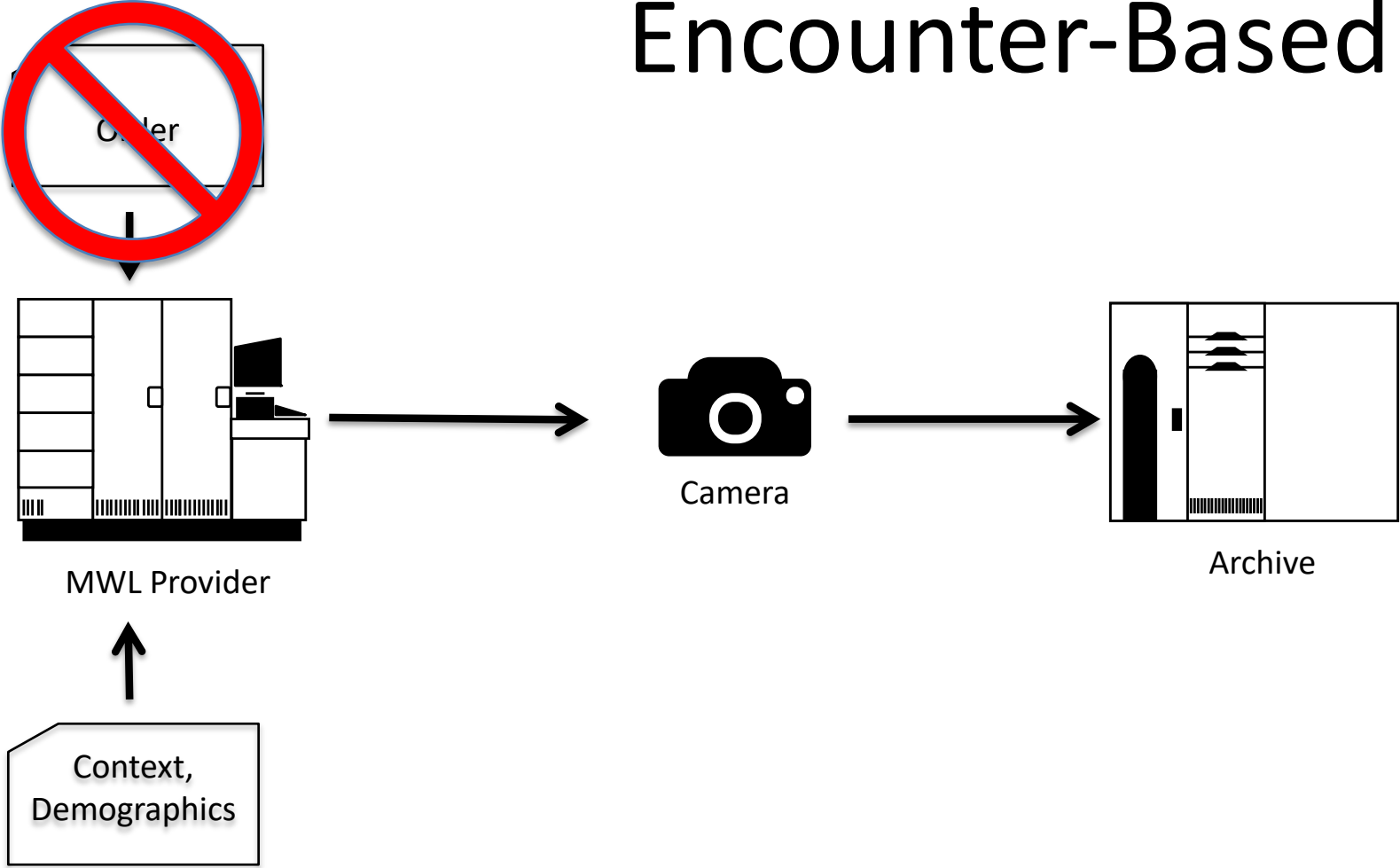

Encounter-Based

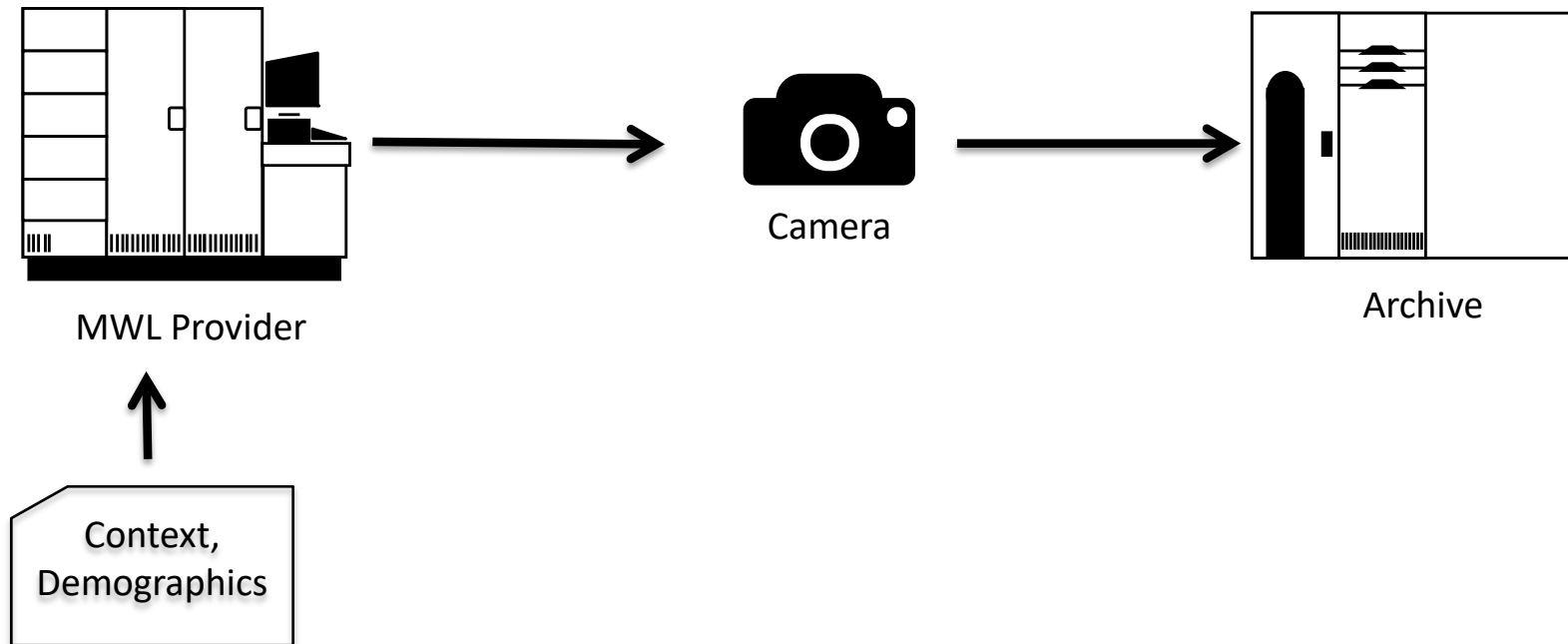

+/- Automatically Generated Order

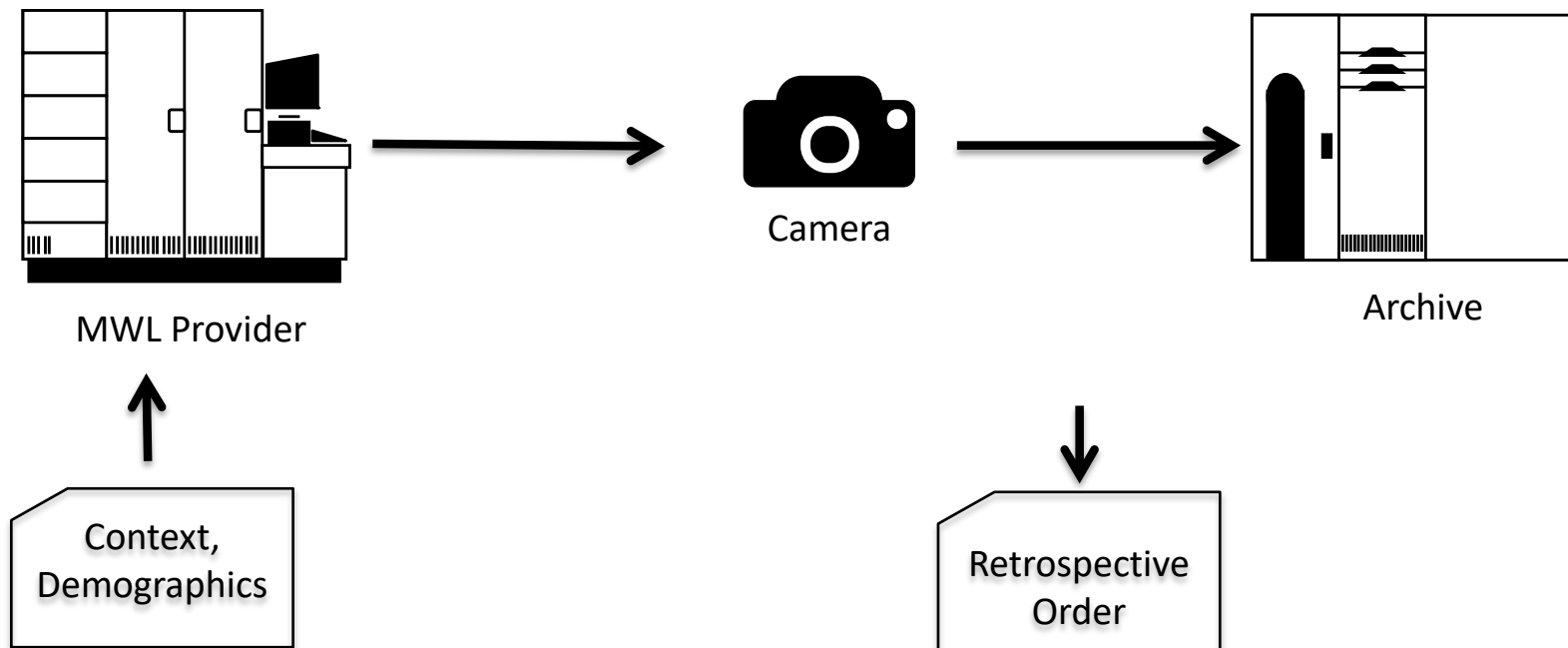

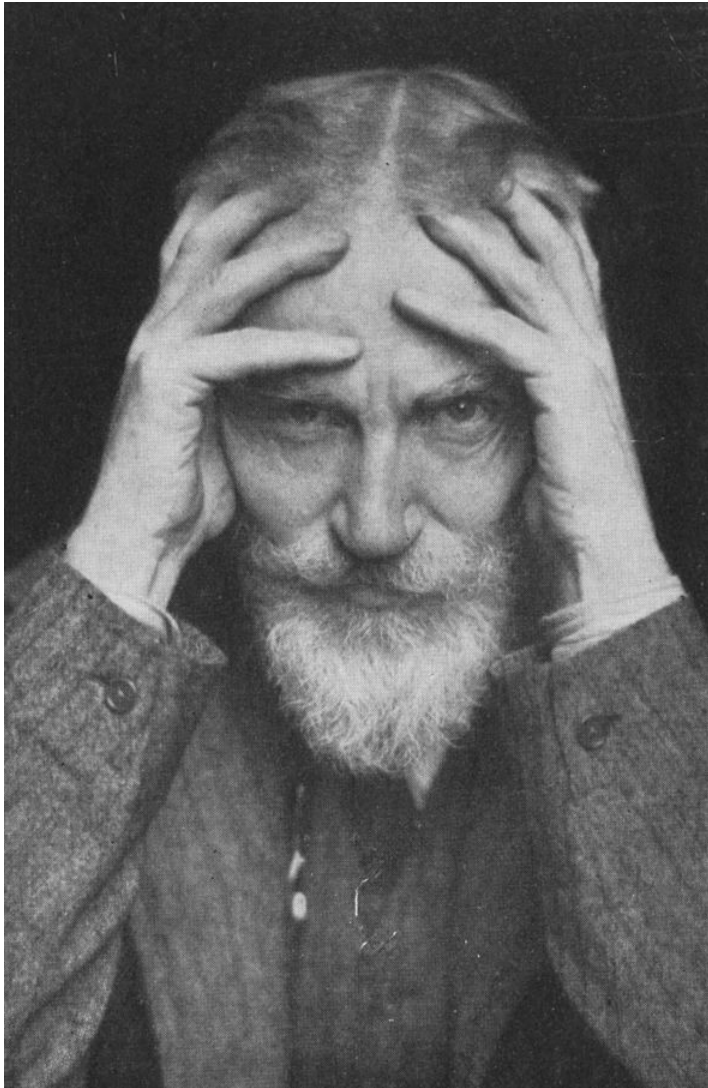

*“Life is not meant to be easy,
my child but take courage: it
can be delightful.”*

Back to Methuselah (1921)

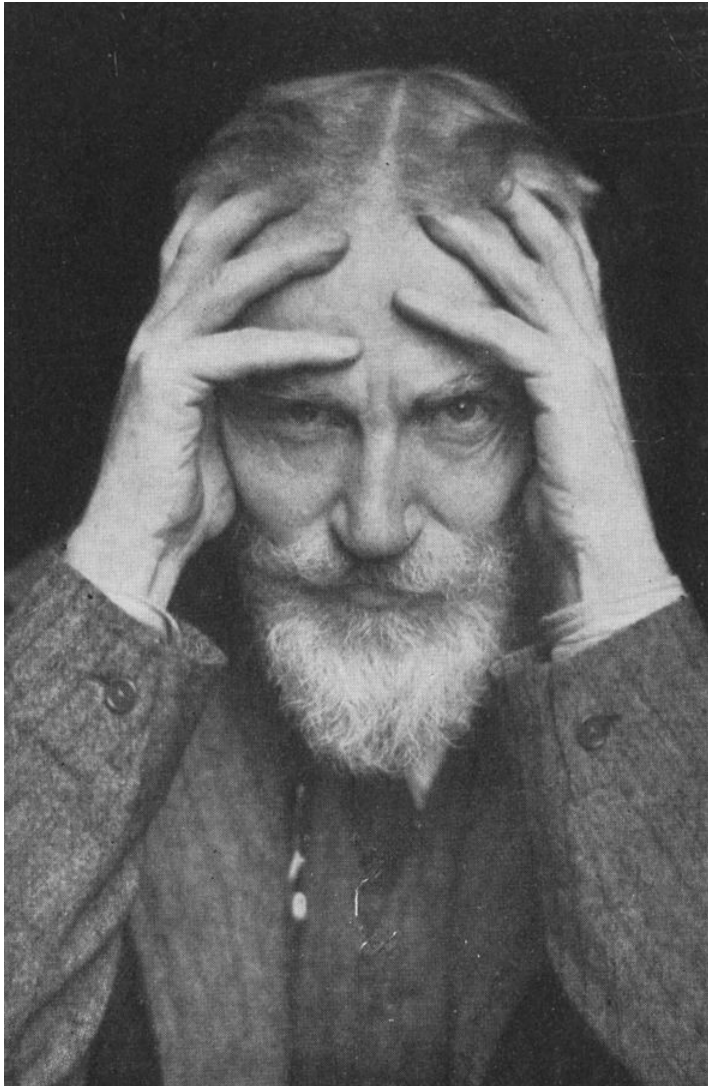

*~~Life~~ is not meant to be easy,
my child but take courage: it
can be delightful.”*

Back to Methuselah (1921)

Making DICOM Easy

- Absolute minimum metadata in JSON + JPEG pixel data payload
- DICOMweb
- WADO-RS
- STOW-RS
- IHE Web-based Image Capture (WIC)

Study Resources and Actions

Verb	Path	Type	Description
POST	{s}/studies	Store PS3.18 6.6.1	Store instances
GET	{s}/studies?...	Query PS3.18 6.7.1	Query for matching studies
GET	{s}/studies/{studyUID}	Retrieve PS3.18 6.5.1	Retrieve entire study
POST	{s}/studies/{studyUID}	Store PS3.18 6.6.1	Store instances
GET	{s}/studies/{studyUID}/metadata	Retrieve PS3.18 6.5.6	Retrieve metadata
GET	{s}/studies/{studyUID}/series?...	Query PS3.18 6.7.1	Query for matching series in a study
GET	{s}/studies/{studyUID}/series/{seriesUID}	Retrieve PS3.18 6.5.2	Retrieve entire series
GET	{s}/studies/{studyUID}/series/{seriesUID}/metadata	Retrieve PS3.18 6.5.6	Retrieve series metadata
GET	{s}/studies/{studyUID}/series/{seriesUID}/instances?...	Query PS3.18 6.7.1	Query for matching instances in a series
GET	{s}/studies/{studyUID}/series/{seriesUID}/instances/{instanceUID}	Retrieve PS3.18 6.5.3	Retrieve instance
GET	{s}/studies/{studyUID}/series/{seriesUID}/instances/{instanceUID}/metadata	Retrieve PS3.18 6.5.6	Retrieve instance metadata
GET	{s}/studies/{studyUID}/series/{seriesUID}/instances/{instanceUID}/frames/{frames}	Retrieve PS3.18 6.5.4	Retrieve frames in an instance
GET	/{bulkdataReference}	Retrieve PS3.18 6.5.5	Retrieve bulk data

More Information

See <http://dicomweb.org> and Part 18 of the DICOM Standard, <http://dicom.nema.org/standard.html>.



Workflow Resources and Actions

Verb	Path	Type	Description
POST	{s}/workitems {?AffectedSOPInstanceUID}	PS3.18 6.9.1	CreateUPS
POST	{s}/workitems/{UPSInstanceUID} {?transaction}	PS3.18 6.9.2	UpdateUPS
GET	{s}/workitems{?query*}	PS3.18 6.9.3	SearchForUPS
GET	{s}/workitems/{UPSInstanceUID}	PS3.18 6.9.4	RetrieveUPS
PUT	{s}/workitems/{UPSInstanceUID}/state	PS3.18 6.9.5	ChangeUPSState
POST	{s}/workitems/{UPSInstanceUID}/ cancelrequest	PS3.18 6.9.6	RequestUPS Cancellation
POST	{s}/workitems/{UPSInstanceUID}/ subscribers/{AETitle}{?deletionlock}	PS3.18 6.9.7	CreateSubscription
POST	{s}/workitems/1.2.840.10008.5.1.4.34.5/	PS3.18 6.9.8	SuspendGlobal Subscription
DELETE	{s}/workitems/{UPSInstanceUID}/ subscribers/{AETitle}	PS3.18 6.9.9	DeleteSubscription
GET	{s}/subscribers/{AETitle}	PS3.18 6.9.10	OpenEventChannel
N/A	N/A	PS3.18 6.9.11	SendEventReport

Payloads

XML	JSON
<pre><NativeDicomModel> <DicomAttribute Tag="00080020" VR="DT" Keyword="StudyDate"> <Value number="1">20130409</value> </DicomAttribute> <DicomAttribute Tag="00080030" VR="TM" Keyword="StudyTime"> <Value number="1">131600.0000</value> </DicomAttribute> ... </NativeDicomModel></pre>	<pre>{ "00080020": { "vr": "DT", "Value": ["20130409"] }, "00080030": { "vr": "TM", "Value": ["131600.0000"] }, ... }</pre>

(these payloads are excerpts to show payload structure; these are not complete)

Color Consistency

- Scenarios
 - images with different color profiles
 - same image different stations
 - same image different screens same station
 - different images on same screen
 - mixing gray and color images on same screen
- Solution
 - ICC Profiles in DICOM header
 - need to be applied by viewing software (using OS platform)

ICC Profile Ignored

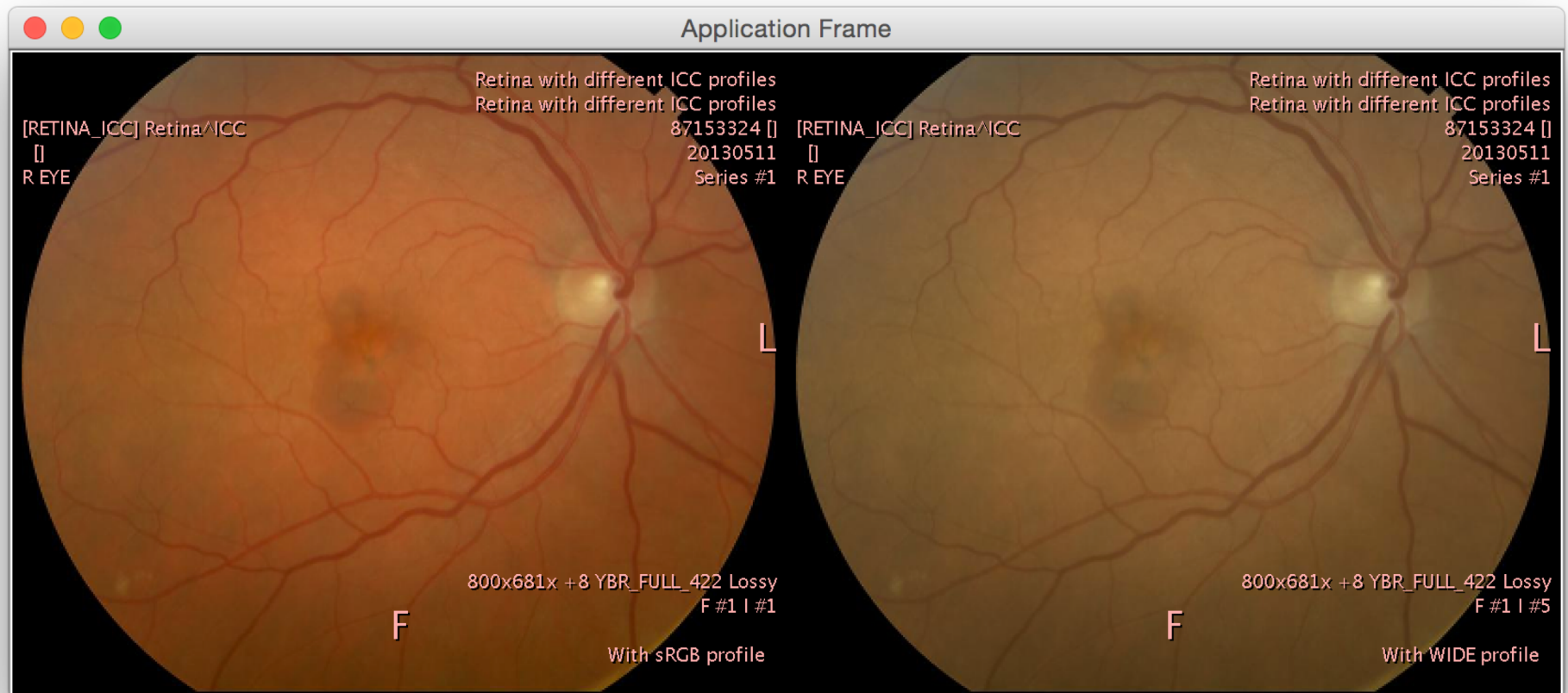

ICC Profile Ignored





Security concerns

- You will be breached
- There is no such thing as a “secure internal” network
- All transactions should be secured (encrypted: DICOM, HTTP over TLS)
- This includes scanner to PACS, camera to PACS, viewer to PACS, ...
- Mobile devices – lack of physical control, BYOD, ...
- Encryption at rest (on disk) as well as in transit (on wire, in air)
- Think beyond regulatory (HIPAA, GDPR) compliance: availability – ransomware
- DICOM defines access control, integrity and encryption mechanisms but hardly anybody implements them or turns them on
- Standards related to access control – IHE Internet User Authentication (IUA) – OAuth, JWT
- A primary motivation for “enterprise” imaging is enterprise level security and reliability provision



Privacy concerns

- Especially challenging for some types of enterprise imaging
- E.g., nude whole body/genitalia, pediatric, distressing photography
- Balance risk against utility, user acceptance and safety
- Genuine patient/worker concern v. obsessive political correctness
- Sensitivity classification flags (different policy for different images)
- Patient consent or restriction flags
- Role based access control (RBAC), Attribute based access control (ABAC), ...
- Patient-specific care team + role in care
- Genuine restriction of access – policy + retrospective audit insufficient
- Beyond state of the art in EMRs, PACS, VNAs as usually deployed???
- Leverage enterprise-wide identity management solutions across EMR & PACS

Technical Challenges

- Interoperability
- Metadata
- Workflow
- Simpler DICOM services (DICOMweb)
- Color Consistency
- Privacy and Security

*We are from Enterprise IT
and are here to help you!*

Not!